









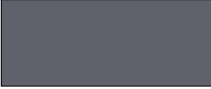

Productdesign: Andreas Bürki und bigla Team

	Silber 180*
	Alu 190*
	Anthrazit metalise 1188**
	Schwarz 157* 1157** NCS S 9000-N
	Anthrazit 158* 1158** NCS S 7502-B
	Hellgrau 159* 1159** NCS S 2502-B
	Weissgrau 160* 1160** NCS S 0502-B
	Rot 165* 1165** NCS S 2570-Y90R
	Dunkelblau 177* 1177** NCS S 7020-R80B
	Gelb 156* 1156** NCS S 1070Y

\* glatt \*\* Feinstruktur



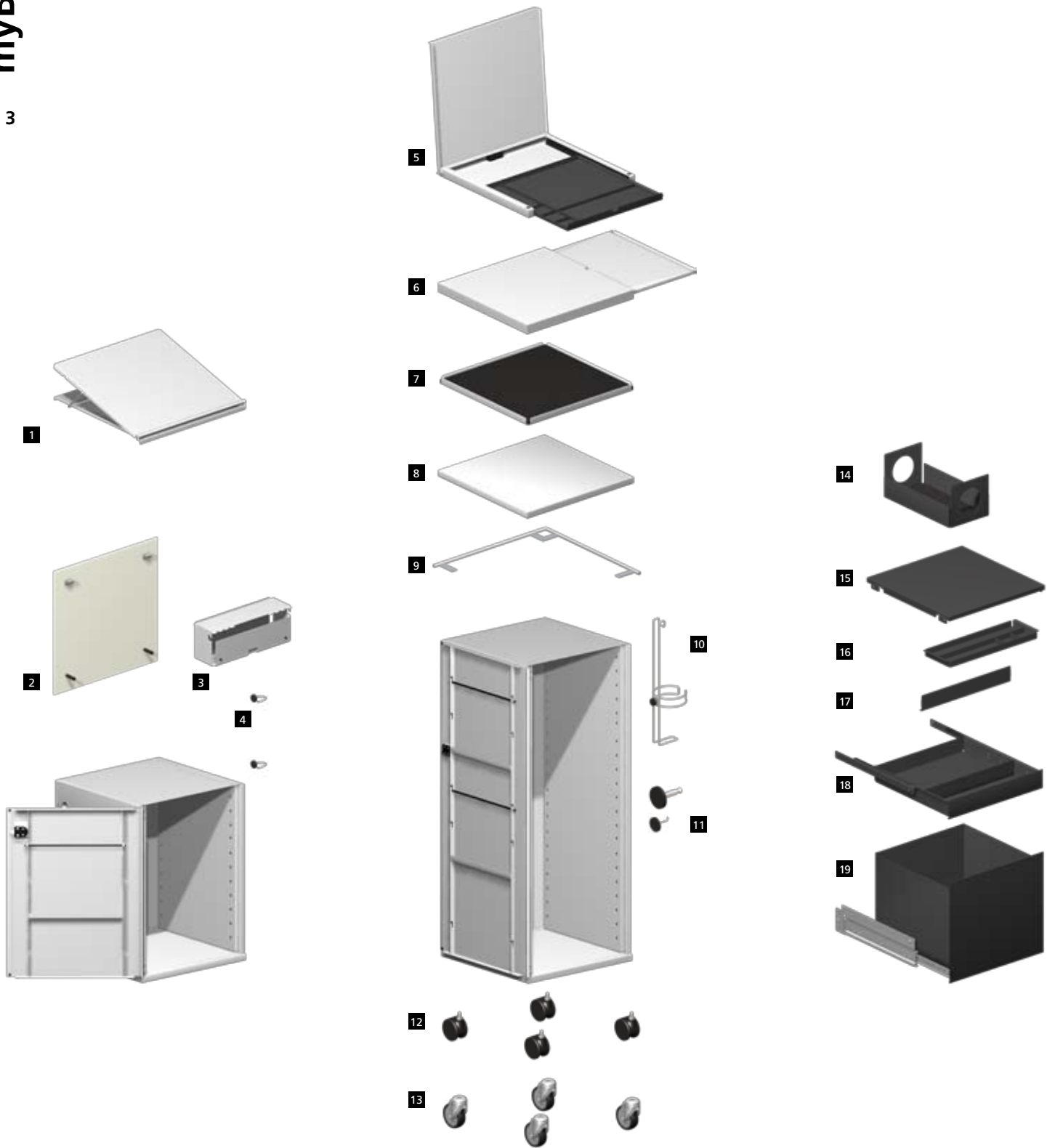

- 1** Aufsatz schrägstellbar
- 2** Displaytafel
- 3** Kabelbox
- 4** Kabelführung magnetisch

- 5** Klappdeckel mit Materialschieber
- 6** Deckel mit Ausziehelement
- 7** Schalendeckel
- 8** Basisdeckel
- 9** Reling
- 10** Flaschenhalter
- 11** Magnete
- 12** Möbelrollen
- 13** Industrierollen

- 14** CD-Box
- 15** Verstelltafeln
- 16** Materialschale
- 17** Unterteiler
- 18** Basisschublade 6 cm – max. Beladung 5 kg
- 19** Schublade A4 – max. Beladung 15 kg (mit Gegengewicht)

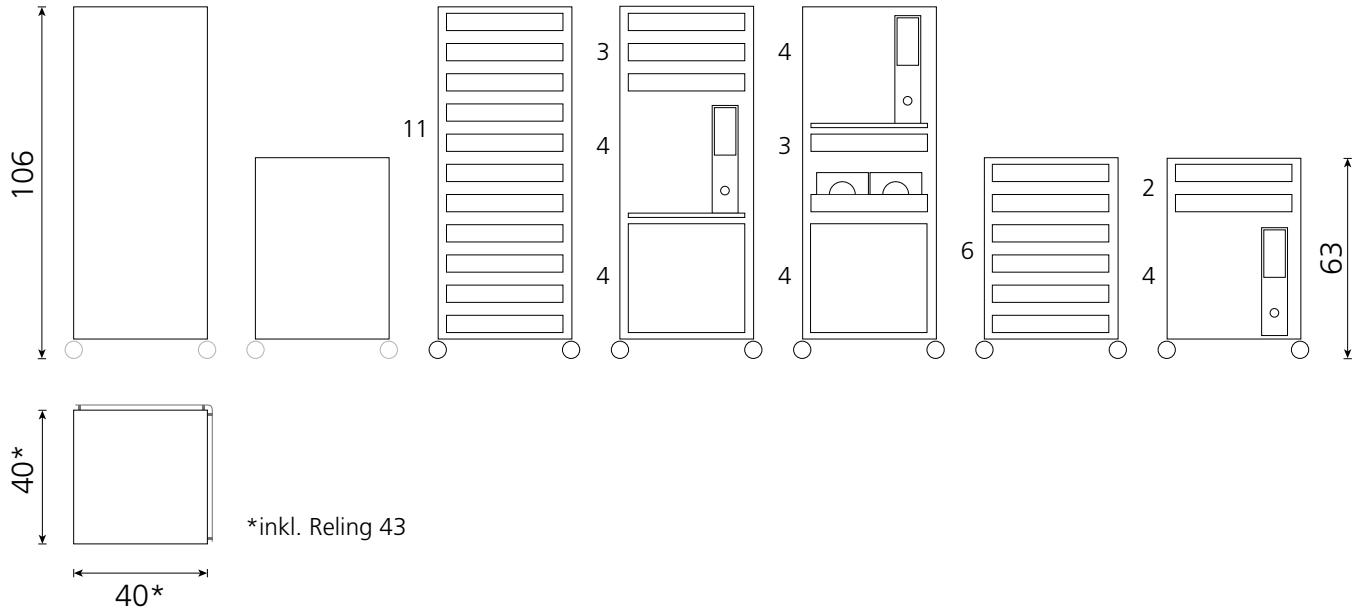

### Beispiele



Beispiel 1



Beispiel 2



Beispiel 3

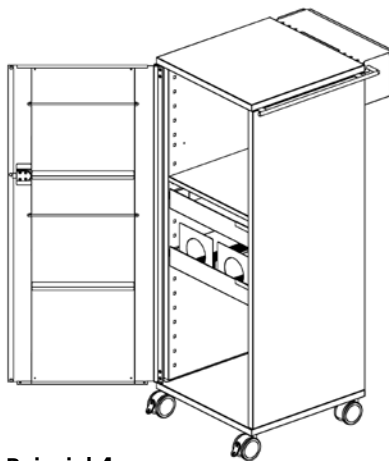

Beispiel 4



Beispiel 5